

INSTALLATION, OPERATION AND MAINTENANCE GUIDE

QPV1 & QPV2

Specifications

Electrical

Supply voltage	15 - 24 VDC
Supply current	350 mA
Command signal voltage	0 - 10 VDC
Command signal impedance	10 kΩ
Analog monitor signal	0 - 10 VDC

Mechanical

Pressure range†	Vacuum - 150 psig (760 mmHg (Vac) - 10.34 Bar)
Output pressure	0 - 100% of range
Flow rate	Varies with inlet valve. See ordering information.
Port size	1/8" NPT
Min closed end volume	1 in ³
Filtration recommended	40 Micron (included)
Linearity/Hysteresis	<±0.02% F.S. BFSL
Repeatability	<±0.02% F.S.
Accuracy	<±0.2% F.S.
Resolution	Up to ±0.005% F.S.

Wetted Parts ‡

Elastomers	Fluorocarbon
Manifold	Brass or aluminum
Valves	Nickel plated brass
Pressure transducer	Silicon, aluminum

Physical

Operating temperature	32 - 158°F (0 - 70°C)
Weight	1.02 lbs (0.50 kg)
Protection rating	IP 65
Housing	Aluminum (anodized)
Finish	Black anodized

† Pressure ranges are customer specified. Output pressures other than 100% are available. ‡ Others available.



QPV1M with digital display

Description

The QPV series valve uses closed loop technology for pressure control. It gives an output pressure proportional to an electrical command signal input. A QPV1 is a single loop unit; a QPV2 is a double loop.

The QPV is a complete closed loop control valve consisting of valves, manifold, housing and electronic controls. Pressure is controlled by the use of two solenoid valves. One valve functions as inlet control, the other as exhaust. The inlet valve operates proportionally to the command supplied by the control circuit. This variable orifice effect allows precise control of pressure at low flow conditions and avoids the digital steps of traditional ON/OFF solenoids. The exhaust solenoid is a standard ON/OFF solenoid and allows excess media to be vented from the system.

The pressure output is measured by an internal pressure transducer and provides a feedback signal to the electronic controls. The QPV2 uses an external pressure transducer to maintain pressure downstream should the application need to be further downstream from the QPV. This external feedback is sent to the electronic controls. This feedback signal is compared with the command signal input. A difference between the two signals causes one of the valves to open, allowing flow in or out of the system. Controlling these two valves maintains accurate pressure.

A monitor output is provided for the system measurement. All QPV1 valves come standard with an analog voltage monitor output. QPV1 monitor output is an amplified signal from the internal pressure transducer.

WARNING

These products are intended for use in industrial compressed gas systems only. Do not use these products where pressures and temperatures exceed the specifications listed.

INSTALLATION

1. Apply a small amount of anaerobic sealant (provided) to the male threads of the in-line filter supplied with valve.
CAUTION: USE ONLY THE THREAD SEALANT PROVIDED. OTHER SEALANTS SUCH AS PTFE TAPE AND PIPE DOPE CAN MIGRATE INTO THE FLUID SYSTEM CAUSING BLOCKAGES AND FAILURES.
2. Install the in-line filter into the port labeled IN on QPV valve.
3. Connect supply line to the in-line filter port.
See Table 1 for rated inlet pressure.
4. Connect device being controlled to port labeled OUT on QPV valve.
5. The valve can be mounted in any position without affecting performance. Mounting bracket QBT-01 (ordered separately) can be used to attach valve to a panel or wall surface.
6. Proceed with electrical connections.

Table 1

Rated Inlet Pressure for Standard QPV Valves

Max calibrated pressure:	Max inlet pressure:
Vacuum - 10 psig (0.69 bar)	Consult factory
10.1 - 30 psig (0.70 - 2 bar)	35 psig (2.4 bar)
31 - 100 psig (2.1 - 7 bar)	110 psig (7.6 bar)
101 - 150 psig (6.96 - 10.3 bar)	160 psig (11 bar)

QPV2 Second Loop Connections

Second loop signal is plugged into auxiliary receptacle on opposite side.

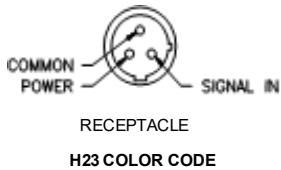

WHITE	SIGNAL IN
BLACK	DC POWER
GREEN	DC COMMON

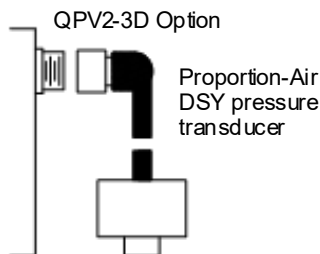

Vacuum Units

1. Connect vacuum supply to the exhaust port E.
2. Leave inlet "IN" port open to atmosphere.
3. Connect the outlet "OUT" port to the device being controlled.
4. Proceed with electrical connection.



QPV1M



QPV2M

ELECTRICAL CONNECTIONS

QPV1

1. Turn off all power to valve.
2. Identify the valve's command input and analog output using the calibration card included in the package and the configuration section on the last page of this sheet.
3. Proceed to the appropriate section corresponding to the type of valve being installed.

NOTE: ALL COLOR CODES RELATE TO THE FACTORY WIRED QBT POWER CORD.

Voltage Command Valves (E, K, V)

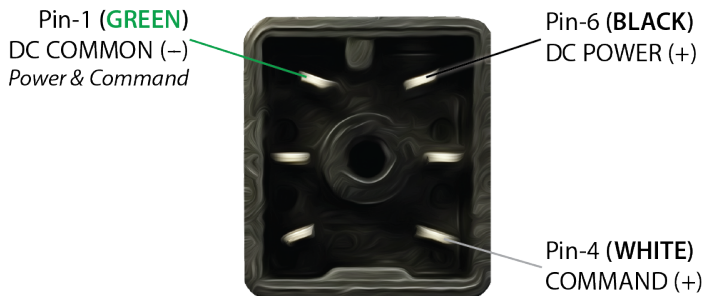

Current Sinking Monitor (EC or IC)

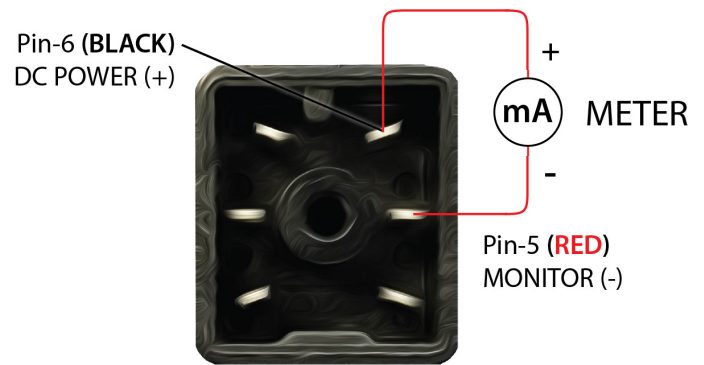

Current Command Valves (I)

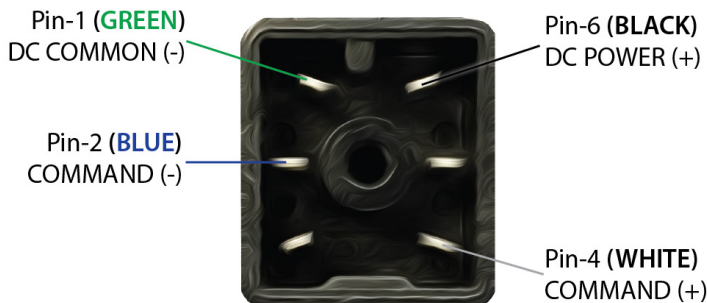

Current Sourcing Monitor (ES or IS)

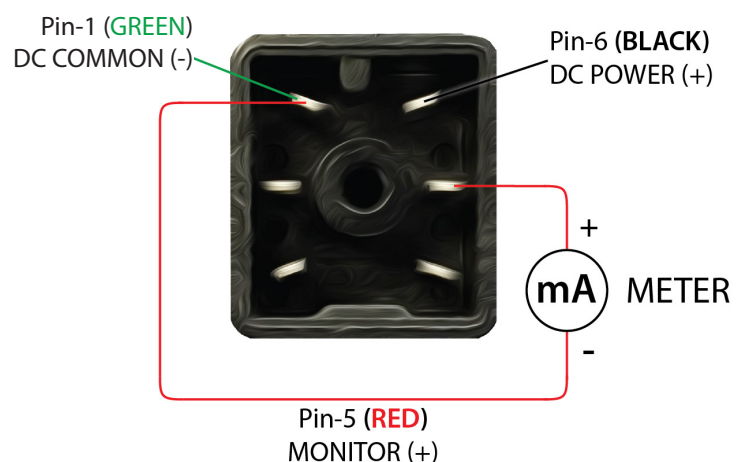

ELECTRICAL CONNECTONS (CONTINUED)

QPV2

1. Turn off all power to valve.
2. Identify the valve's command input and analog output using the calibration card included in the package and the configuration section in this document.
3. Proceed to the appropriate section corresponding to the type of valve being installed.

NOTE: ALL COLOR CODES RELATE TO THE FACTORY WIRED QBT POWER CORD.

Voltage Command Valves (E, K, V)

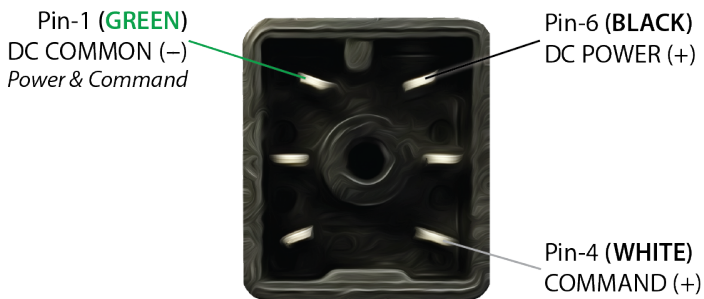

Current Command Valves (I)

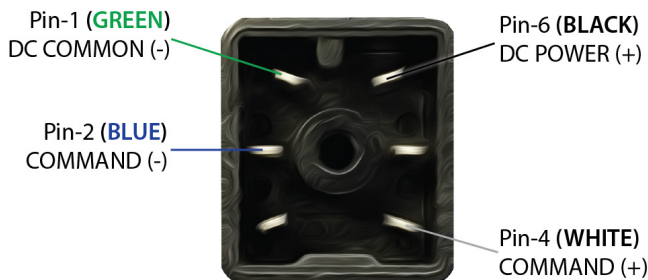

Voltage Monitor (E, K, V)

Monitoring the Internal Sensor

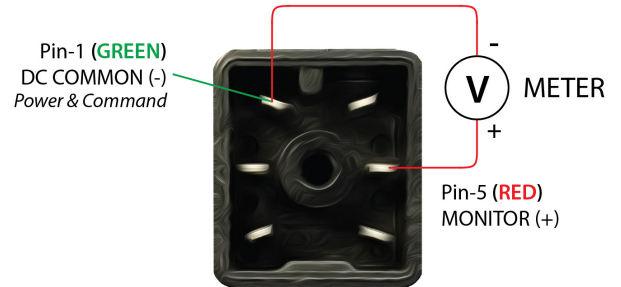

Monitoring the External Sensor

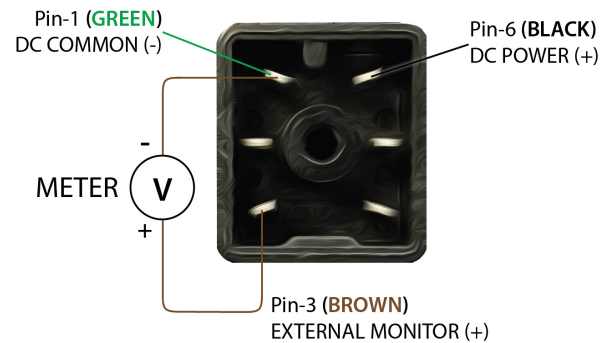

Current Sinking Monitor (C)

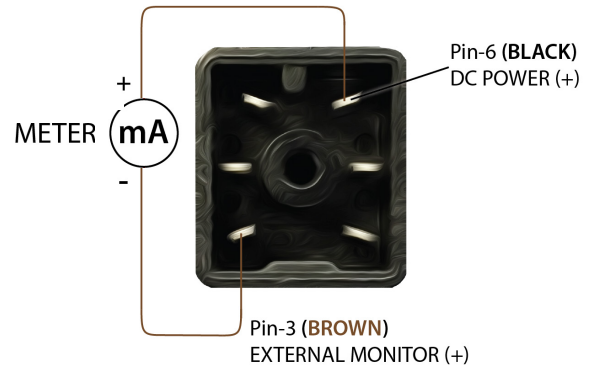

Current Sourcing Monitor (S)

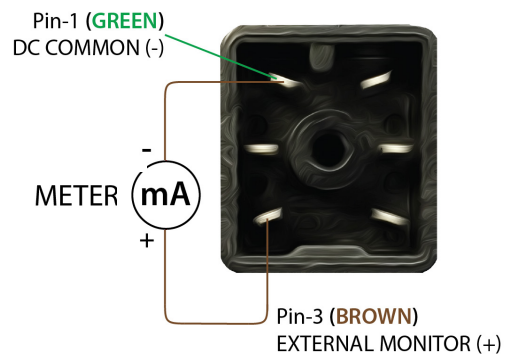

RECALIBRATION PROCEDURE - QPV1 (CONTACT FACTORY FOR QPV2)

All QPV control valves come calibrated from the factory by trained personnel using precision calibration equipment. The QPV valve is a closed loop control valve using a precision electronic pressure sensor. Typical drift is less than 1% over the life of the product. If your QPV valve appears to be out of calibration by more than 1%, it is not likely to be the QPV. Check the system for adequate supply pressure, wiring and electronic signal levels. Verify the accuracy of your measuring equipment before re-calibrating. Consult factory if you have any questions or require assistance. If the QPV valve needs re-calibration, use the procedure described below:

1. Identify the inputs and outputs of the valve using the model number of the valve, calibration card included with the valve, and the information provided in this sheet.
2. Connect a precision measuring gage or pressure transducer to the OUT port of the QPV.
3. Connect the correct supply source to the IN port of the QPV, making sure the pressure does not exceed the rating for the valve.
4. Locate the plastic calibration access cap on top of the QPV valve and completely remove it. Located underneath are two adjustment trim pots, Zero "Z" and Span "S". See Figure 1 for pots location.
5. **NOTE: Only use this step if your device is totally out of calibration.** If it is slightly out of calibration, omit this step and move on to Step 6. Using a small screwdriver, turn both trim pots 15 turns clockwise. Then turn both trim pots 7 turns counterclockwise. This will put the QPV roughly at mid-scale.
6. Make correct electrical connections as noted. Make sure there is a proper meter in place to measure the command input to the QPV.
7. Set the electrical command input to MAXIMUM value.
8. Adjust the SPAN pot until MAXIMUM desired pressure is reached (clockwise increases pressure).
9. Set the electrical command input to MINIMUM value.
10. Adjust the ZERO pot until MINIMUM desired pressure is reached (clockwise increases pressure).
11. Repeat ZERO and SPAN adjustments, which interact slightly, until QPV valve is calibrated back to proper range. Step 7 - 10.
12. Replace calibration access cap.
13. Set the electrical command input to MAXIMUM value.
14. Adjust the SPAN pot until MAXIMUM desired pressure is reached (clockwise increases pressure).
15. Set the electrical command input to MINIMUM value.
16. Adjust the ZERO pot until MINIMUM desired pressure is reached (clockwise increases pressure).
17. Repeat ZERO and SPAN adjustments, which interact slightly, until QPV valve is calibrated back to proper range. Step 7 - 10.
18. Replace calibration access cap.

NOTE: The QPV uses an advanced analog PID circuit to modulate the internal solenoid valves. These potentiometers are set at the factory and should not require adjustment. These settings are based on the specific parameters of your application. If the response of the QPV requires adjustment, contact the factory for special instructions.

QPV POTENTIOMETERS

Do not modify unless instructed to by factory

PROPORTIONAL: This is the actual difference between the command and pressure transducer feedback. This POT controls the amount of that error signal that gets to the control circuit. Like a volume on a radio, the higher the POT setting the more the 'real time' error signal affects the output.

BIAS: Opens up the resistance window to allow the valves to adjust a little slower. The higher the Bias, the less pressure is needed to open the inlet valve. The Bias provides a steady state current to the valve to get it closer to opening with zero command. Clockwise increases the current to the valve and counterclockwise decreases the current. A setting of Zero is often acceptable. Less bias generally does not negatively impact the operation of the unit unless the system flow rates are relatively high compared with the full flow capability of the valve.

INTEGRAL: Any steady state error signal present between the command signals versus the feedback signal, is integrated over time until a control action balances it. In essence, it reaches equilibrium with the system which allows the inlet valve to be slightly open to maintain pressure in the system due to a leak or a system process. The integral sets the amount of this signal that is fed to the valve control. If this signal is too high it will cause the unit to slowly oscillate (loping sound from the unit).

PID SETTINGS
PID pots should not require adjustment. Set at the factory based on specific parameters of your Application.

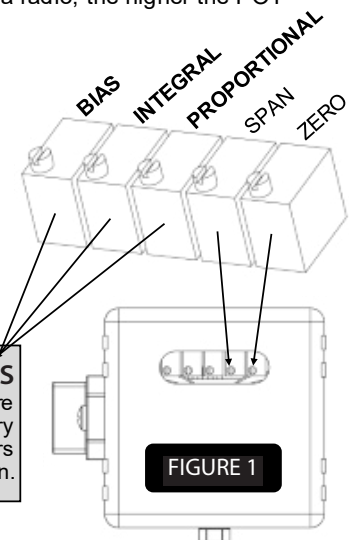

DIMENSIONS

QPV1

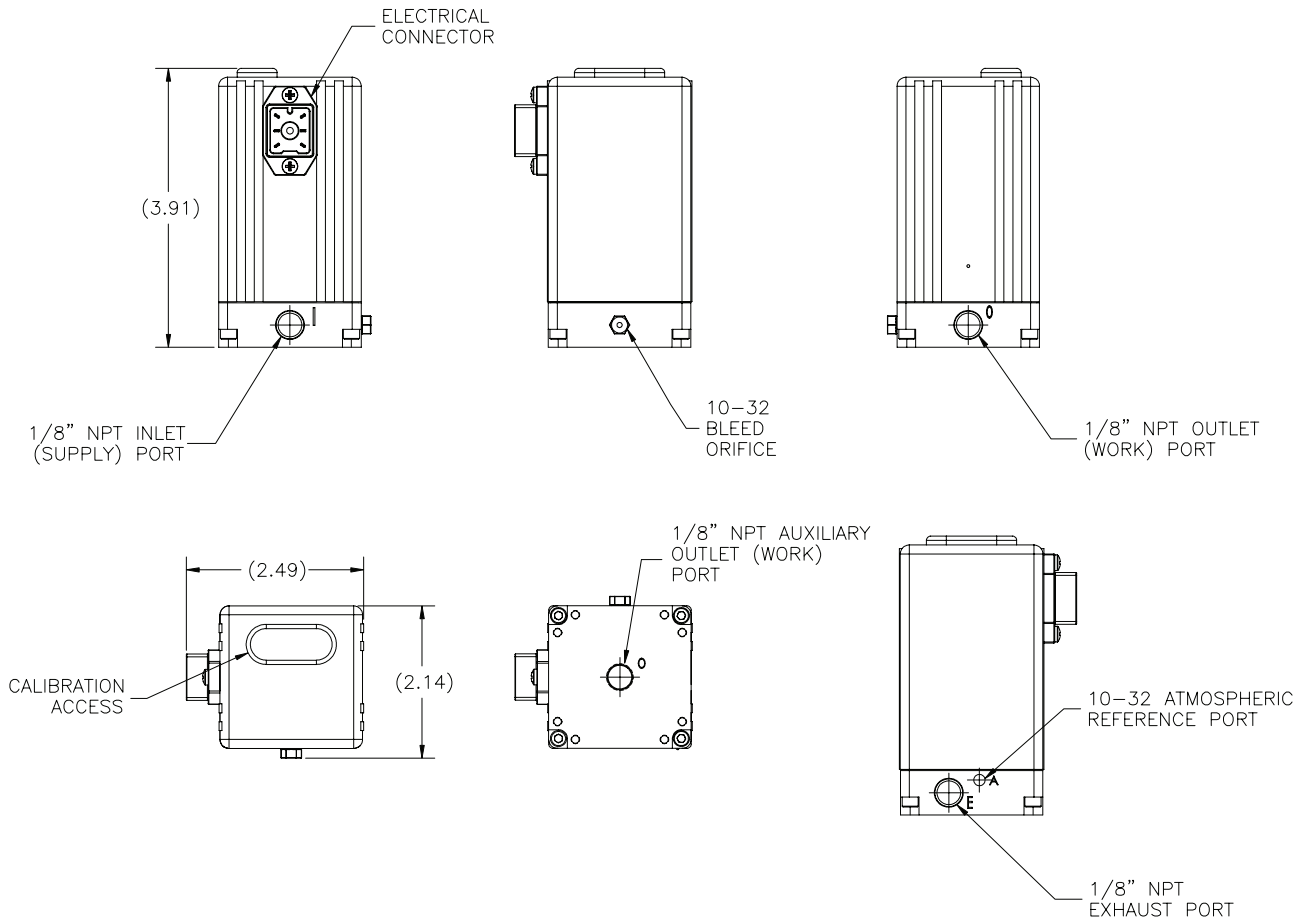

QPV2

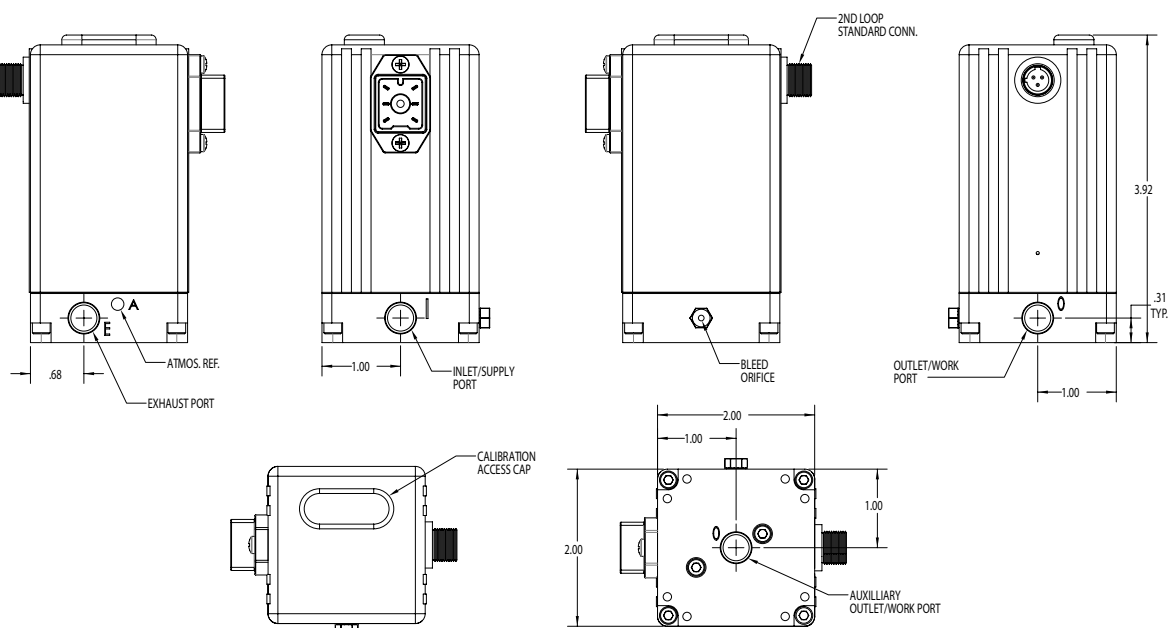

Notes:

1. All dimensions are in inches
2. All dimensions are for reference only.

CONFIGURATION

QPV

ACCURACY	±0.2% F.S.	PRESSURE	Full Vac to 150 PSIG (10 Bar)
PORT SIZE	1/8"	MAX FLOW	1 SCFM (28 SLPM)

The QPVM replaces the QPVT for all new applications.

Example Part Number	QPV	2	M	B	N	E	E	Z		P	10	BR	G	A	X	L	3D	TF
Section Reference ->	1		2	3	4	5	6	7	8	9	10	11	12	13	14	OPTIONS		

1	Type
1	Single Loop
2	Dual Loop

2	Manifold Material
A	Anodized Aluminum
B	Brass

3	Thread Type
N	NPT
P	BSPP

4	Command Signal Range
E	0 to 10 VDC
I	4 to 20 mA
K	0 to 5 VDC
V	1 to 5 VDC (Requires V for Monitor Signal #5)
A	RS232 Modbus Serial Command (Requires X for Monitor Signal #5)
B	RS485 Modbus Serial Command (Requires X for Monitor Signal #5)
N	Ethernet/Proportion-Air (Requires X for Monitor Signal #5)
P	P2 Profiler (Integrated)

5	Monitor Signal Range
X	No Monitor
E	0 to 10 VDC
K	0 to 5 VDC (Requires E, I or K for Command Signal Range #4)
V	1 to 5 VDC (Requires V for Command Signal Range #4)
C	4 to 20 mA (Sinking)
S	4 to 20 mA (Sourcing)

6	Zero Offset
N	0% Pressure is Below Zero
P	0% Pressure is Above Zero
Z	0% Pressure is Zero (Typical)

7	Zero Offset Pressure
Typical is 0% - If greater than 30% of full scale pressure (#9), please consult factory.	
*If Z for Zero Offset, Please Leave this Section (#7) Blank	

8	Full Scale Pressure Type
N	100% Pressure is Below Zero
P	100% Pressure is Above Zero
Z	100% Pressure is Zero

9	Full Scale Pressure
Must be between less than or equal to 150 psig*	
*Adder if Full Scale Pressure <13.5" H2O	

10	Pressure Unit		
PS	PSI	Inches Hg	IH
MB	Millibars	Inches H ₂ O	IW
BR	Bar	Millimeters H ₂ O	MW
KP	Kilo-pascal	Kilograms/cm ²	KG
MP	Mega-pascal	Torr (Requires A for Unit of Measure #11)	TR
MH	Millimeters Hg	Centimeters H ₂ O	CW
PA	Pascal		

11	Pressure Unit of Measure
A	Absolute Pressure
D	Differential Pressure
G	Gauge Pressure

12	Inlet Valve
A	0.013" (proportional valve)
B	0.025" (proportional valve)
C	0.040" (proportional valve)
D	0.060" (proportional valve)
E	0.089" (proportional valve)
N	No Inlet Valve*
X	0.040"* (digital valve)
*Vacuum Pressure Units Only	
Adder if two proportional valves are selected.	

13	Outlet Valve
A	0.013" (proportional valve)
B	0.025" (proportional valve)
C	0.040" (proportional valve)
D	0.060" (proportional valve)
E	0.089" (proportional valve)
N	No Exhaust Valve
X	0.040" (digital valve)

14	Bleed Orifice
N	No Bleed Orifice
L	Factory Standard Bleed Orifice (0.004")
2	Non-Standard Bleed Orifice (0.002")

PLEASE CONTACT FACTORY FOR VALVE & ORIFICE SELECTION

Inlet valve orifice size and the exhaust valve are factory determined based on the application's flow and pressure specs. Bleed orifice is required when the QPV is used in an application that is static (no flow). Dynamic applications (under flow) do not require a bleed orifice to function properly. Please consult our Applications Team for your specific application needs. We are here to help you.



Options	
3D	3-Pin Connector
BF	Bottom Mount 1/4" Male Fitting
BR	Foot-Mounted Bracket + Install
DD	Digital Display
O2*	Oxygen Cleaned
O3	Oxygen Cleaned Non-O2 Use
P1	12-VDC Power

Recommended Accessories	
QBT-C-6	6 ft. Power/Command/Monitor Cable
QBT-01	Wrap-Around Mounting Bracket
QBTS-02*	Uninstalled Foot-Mount Bracket and Screws
*Include BR option on part number for factory-installed foot mount bracket	

*O2 cleaning only available on brass manifold. Many other options are available. Please consult factory for more information.

SAFETY PRECAUTIONS

Please read the following safety information before installing or operating any Proportion-Air, Inc. equipment or accessories. To confirm safety, observe 'ISO 4414: Pneumatic Fluid Power - General rules relating to systems' and other safety practices.

WARNING

Improper operation could result in serious injury or loss of life!

1. PRODUCT COMPATIBILITY

Proportion-Air, Inc. products and accessories are for use in industrial pneumatic applications with compressed air media. The compatibility of the equipment is the responsibility of the end user. Product performance and safety are the responsibility of the person who determined the compatibility of the system. Also, this person is responsible for continuously reviewing the suitability of the products specified for the system, referencing the latest catalog, installation manual, Safety Precautions and all materials related to the product.

2. EMERGENCY SHUTOFF

Proportion, Inc. products cannot be used as an emergency shutoff. A redundant safety system should be installed in the system to prevent serious injury or loss of life.

3. EXPLOSIVE ATMOSPHERES

Products and equipment should not be used where harmful, corrosive or explosive materials or gases are present. Unless certified, Proportion-Air, Inc. products cannot be used with flammable gases or in hazardous environments.

4. AIR QUALITY

Clean, dry air is not required for Proportion-Air, Inc. products. However, a 40 micron particulate filter is recommended to prevent solid contamination from entering the product.

5. TEMPERATURE

Products should be used with a media and ambient environment inside of the specified temperature range of 32°F to 158°F. Consult factory for expanded temperature ranges.

6. OPERATION

Only trained and certified personnel should operate electronic and pneumatic machinery and equipment. Electronics and pneumatics are very dangerous when handled incorrectly. All industry standard safety guidelines should be observed.

7. SERVICE AND MAINTENANCE

Service and maintenance of machinery and equipment should only be handled by trained and experienced operators. Inspection should only be performed after safety has been confirmed. Ensure all supply pressure has been exhausted and residual energy (compressed gas, springs, gravity, etc.) has been released in the entire system prior to removing equipment for service or maintenance.

CAUTION

Improper operation could result in serious injury to people or damage to equipment!

1. PNEUMATIC CONNECTION

All pipes, pneumatic hose and tubing should be free of all contamination, debris and chips prior to installation. Flush pipes with compressed air to remove any loose particles.

2. THREAD SEALANT

To prevent product contamination, thread tape is not recommended. Instead, a non-migrating thread sealant is recommended for installation. Apply sealant a couple threads from the end of the pipe thread to prevent contamination.

3. ELECTRICAL CONNECTION

To prevent electronic damage, all electrical specifications should be reviewed and all electrical connections should be verified prior to operation.

EXEMPTION FROM LIABILITY

1. Proportion-Air, Inc. is exempted from any damages resulting from any operations not contained within the catalogs and/or instruction manuals and operations outside the range of its product specifications.

2. Proportion-Air, Inc. is exempted from any damage or loss whatsoever caused by malfunctions of its products when combined with other devices or software.

3. Proportion-Air, Inc. and its employees shall be exempted from any damage or loss resulting from earthquakes, fire, third person actions, accidents, intentional or unintentional operator error, product misapplication or irregular operating conditions.

4. Proportion-Air, Inc. and its employees shall be exempted from any damage or loss, either direct or indirect, including consequential damage or loss, claims, proceedings, demands, costs, expenses, judgments, awards, loss of profits or loss of chance and any other liability whatsoever including legal expenses and costs, which may be suffered or incurred, whether in tort (including negligence), contract, breach of statutory duty, equity or otherwise.

WARRANTY

Proportion-Air, Inc. products are warranted to the original purchaser only against defects in material or workmanship for eighteen (18) months from the date of manufacture. The extent of Proportion-Air's liability under this warranty is limited to repair or replacement of the defective unit at Proportion-Air's option. Proportion-Air shall have no liability under this warranty where improper installation or filtration occurred.

PROPORTION

ProportionAir.com

8250 N 600 W

P.O. Box 218

McCordsville, IN 46055

info@proportionair.com

Handcrafted in the USA
ISO 9001-2015 Certified